

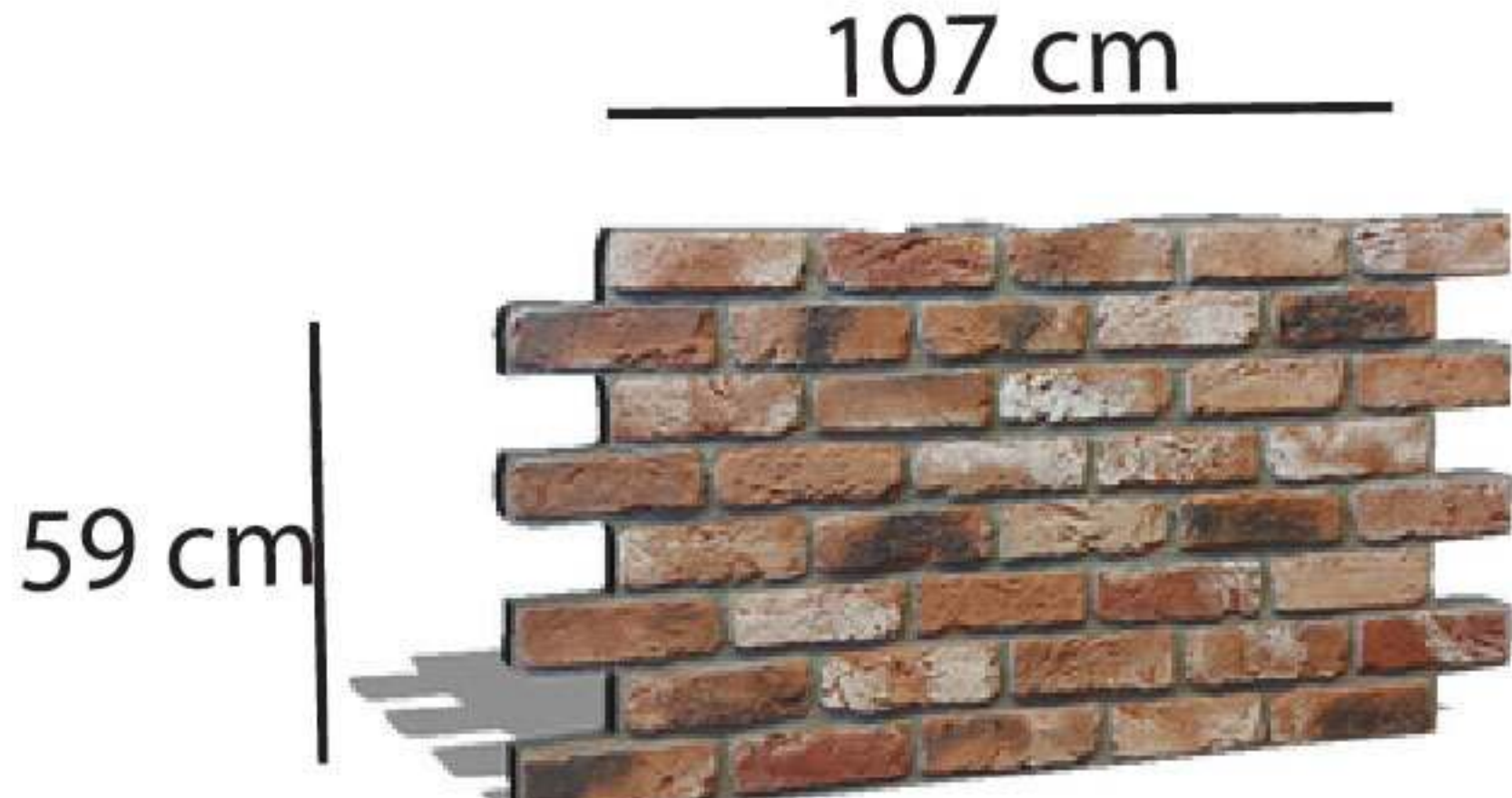

POLYURETHANE BASED
WALL DECORATION PRODUCTS

Ladrillo Barock



Dimensions : 0,6313 m²
Thickness : 2,7 cm

Tudor



Blancura

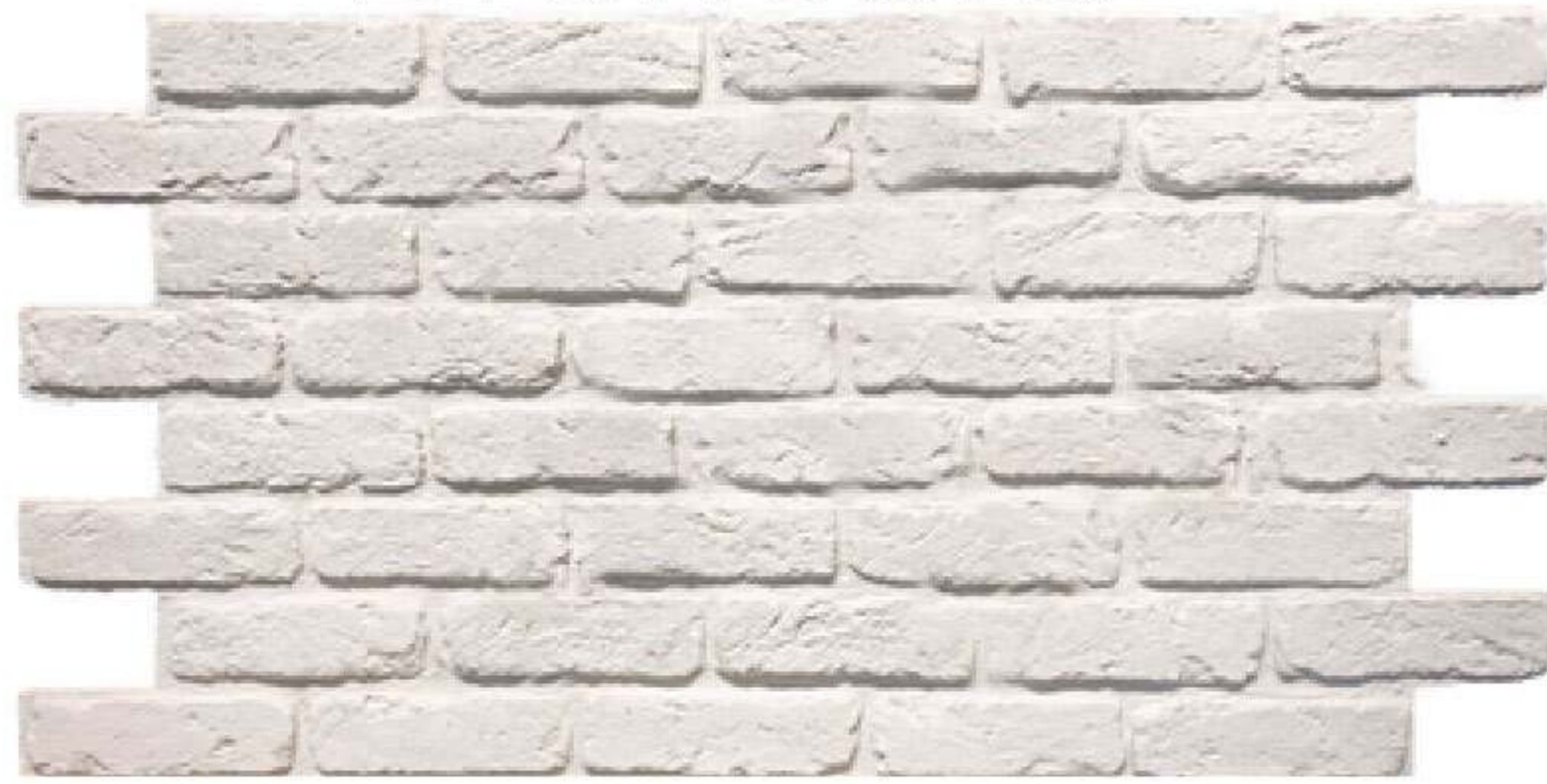

Rustic

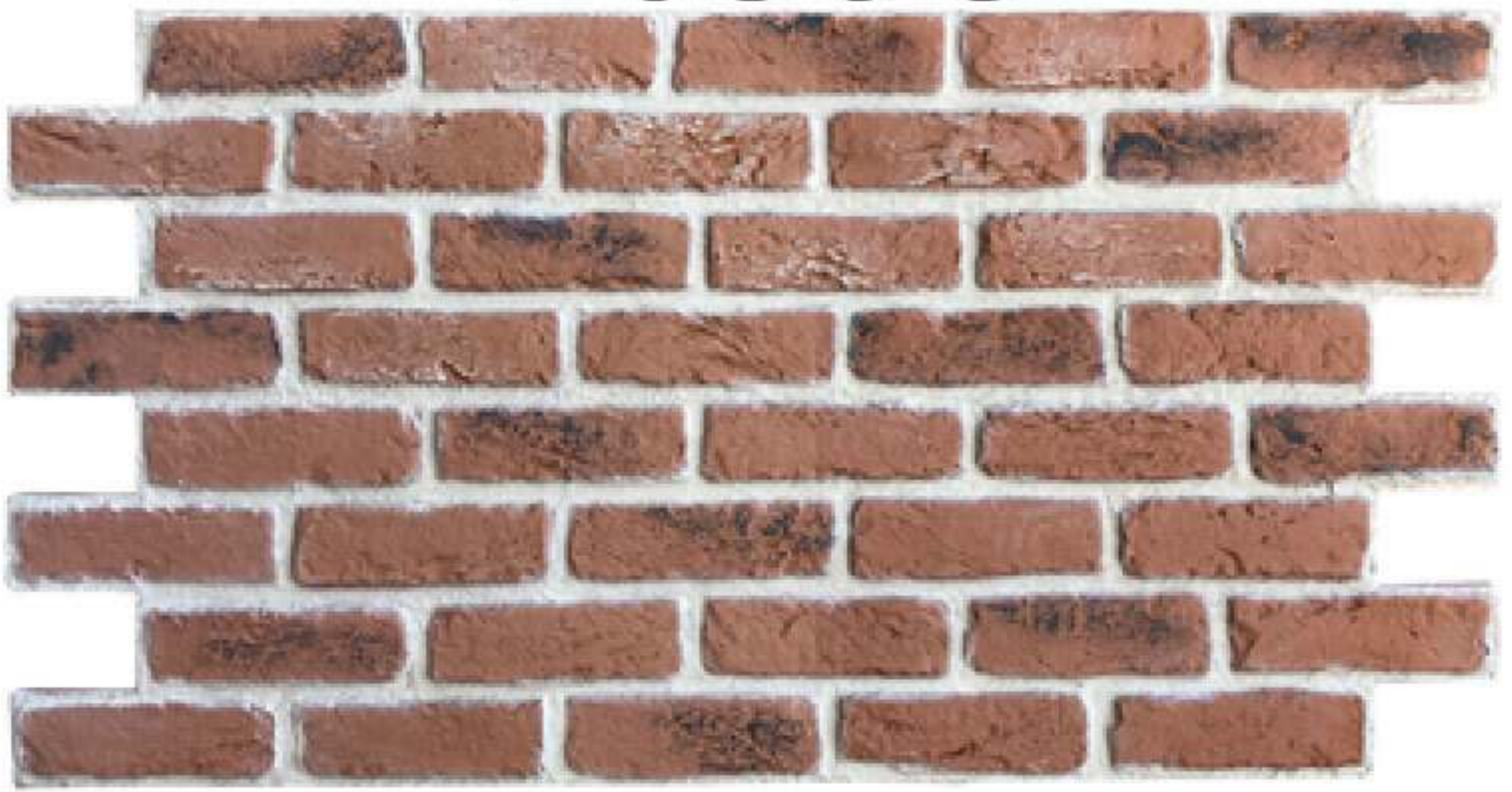

Raja

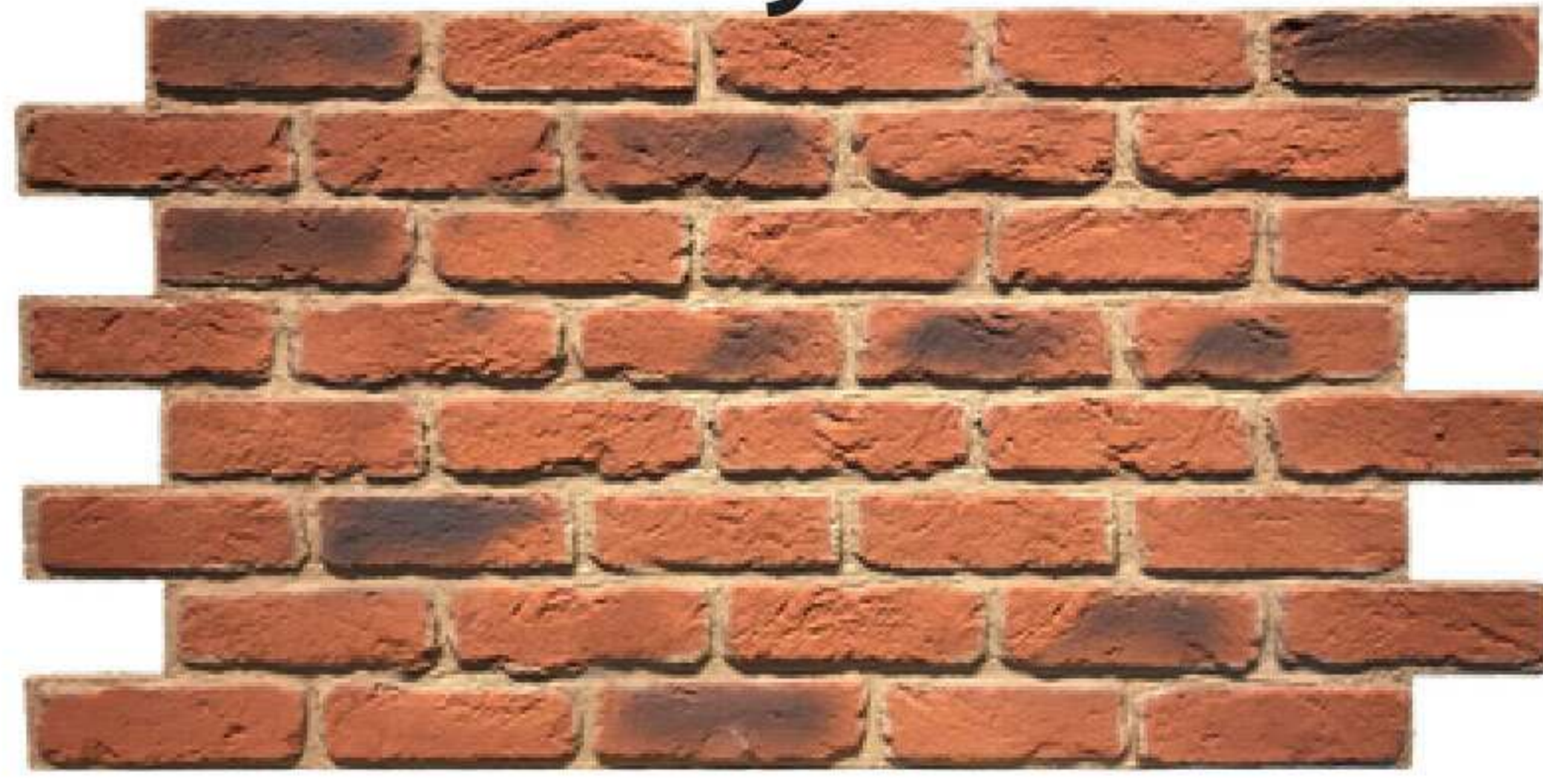

Dark Rustic



New Marron



Grey



Suelo





Ladrillo Vintage

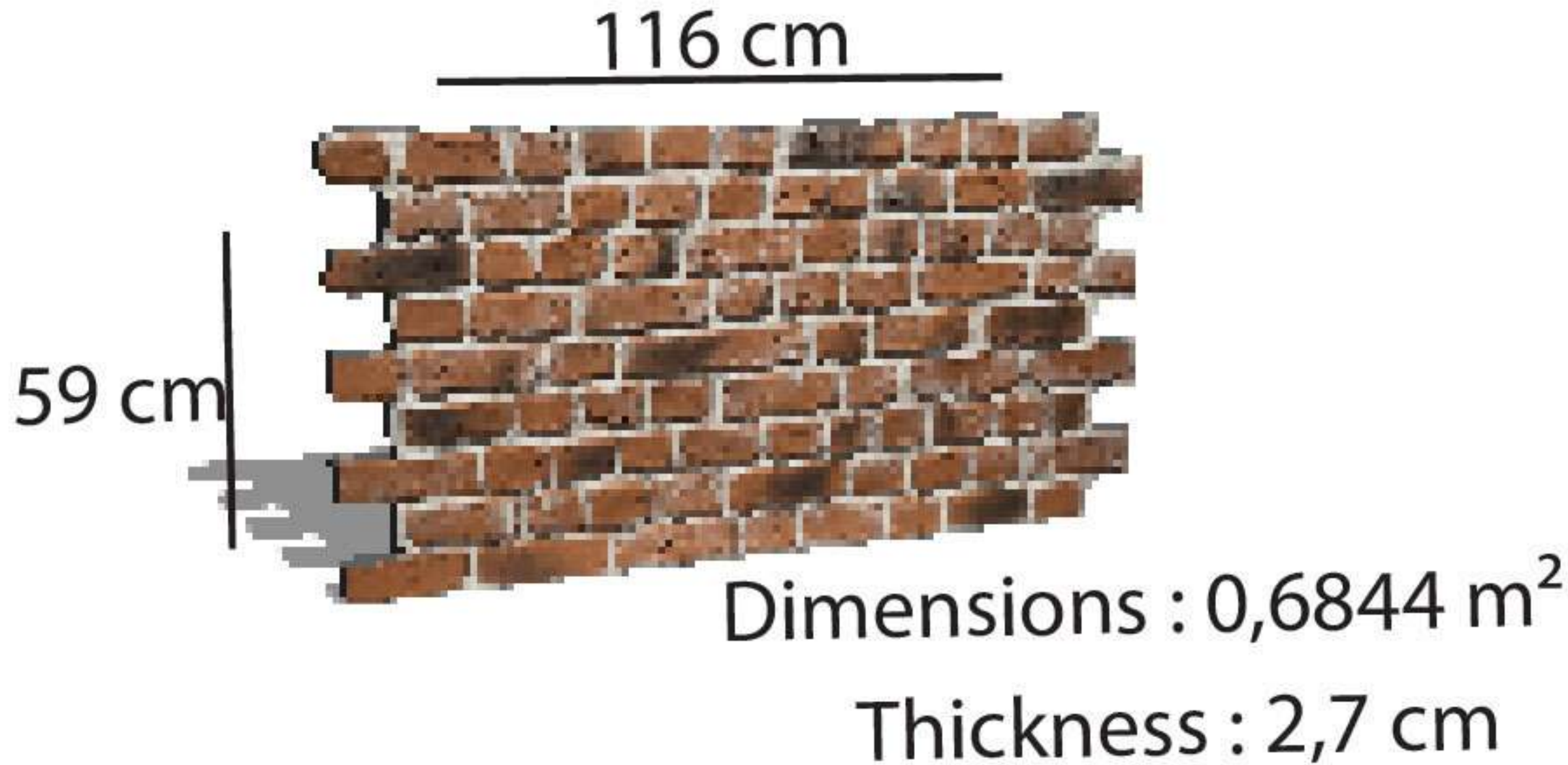

Negra



Rustic

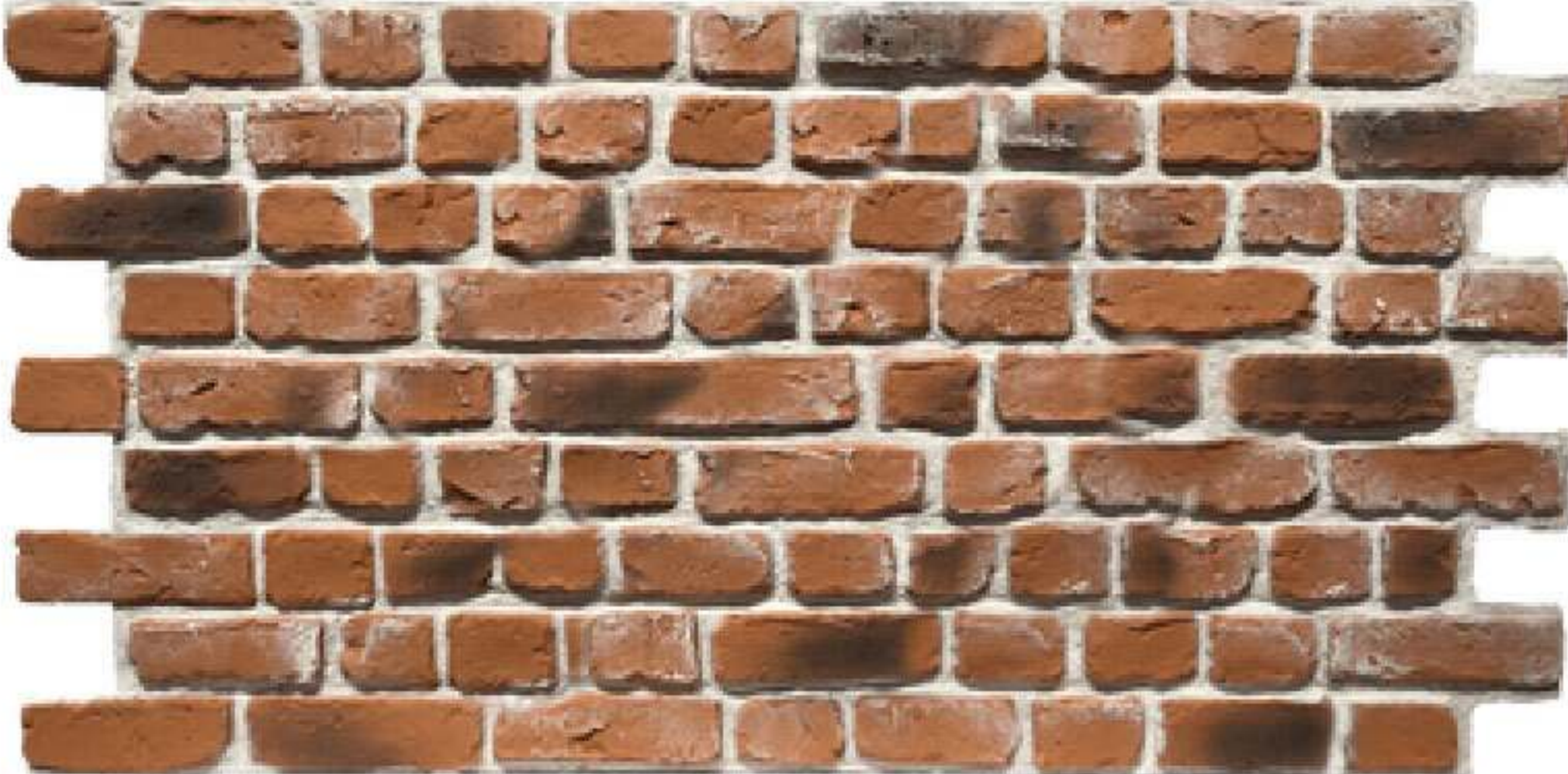

Blancura

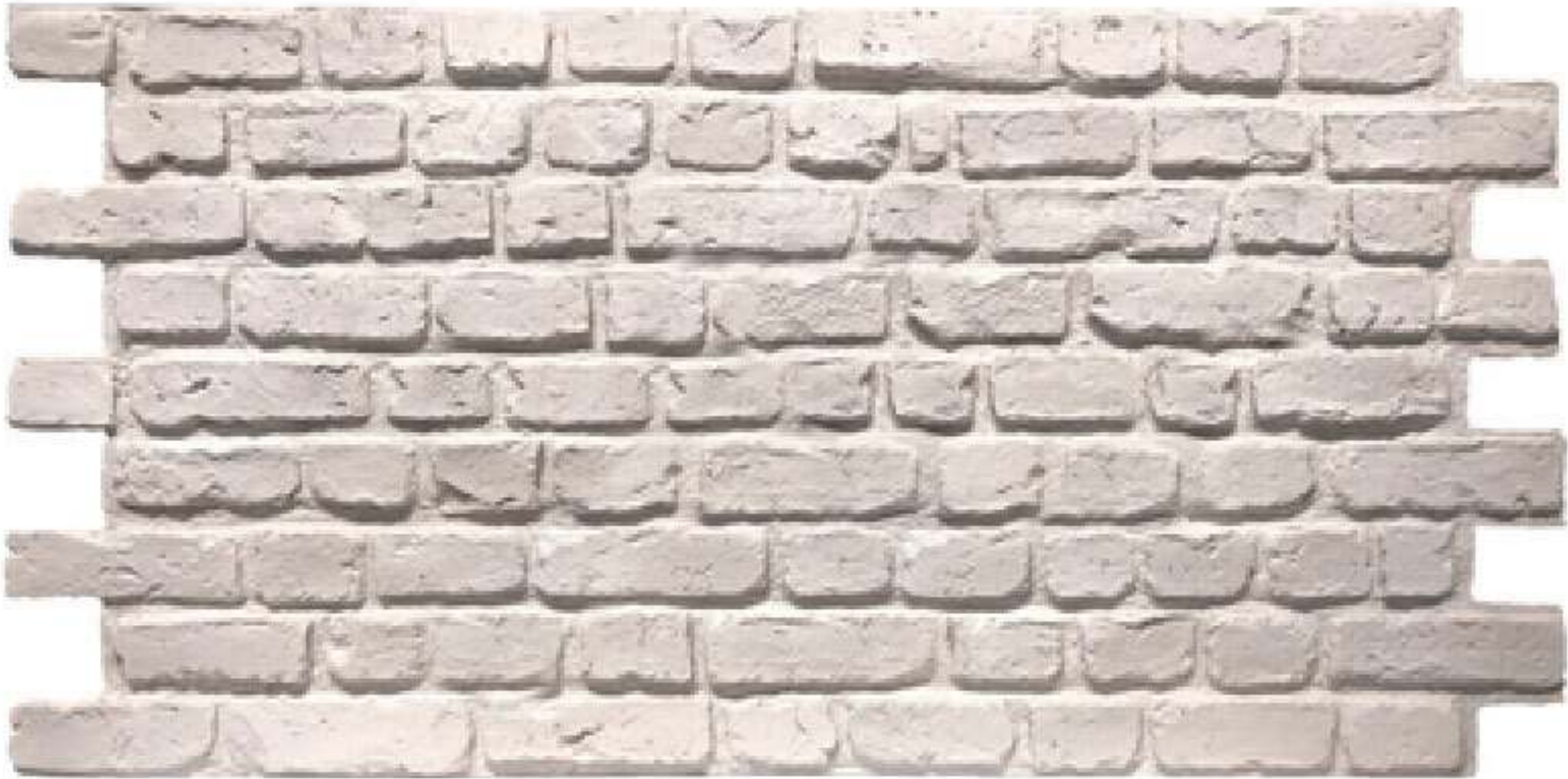

Raja

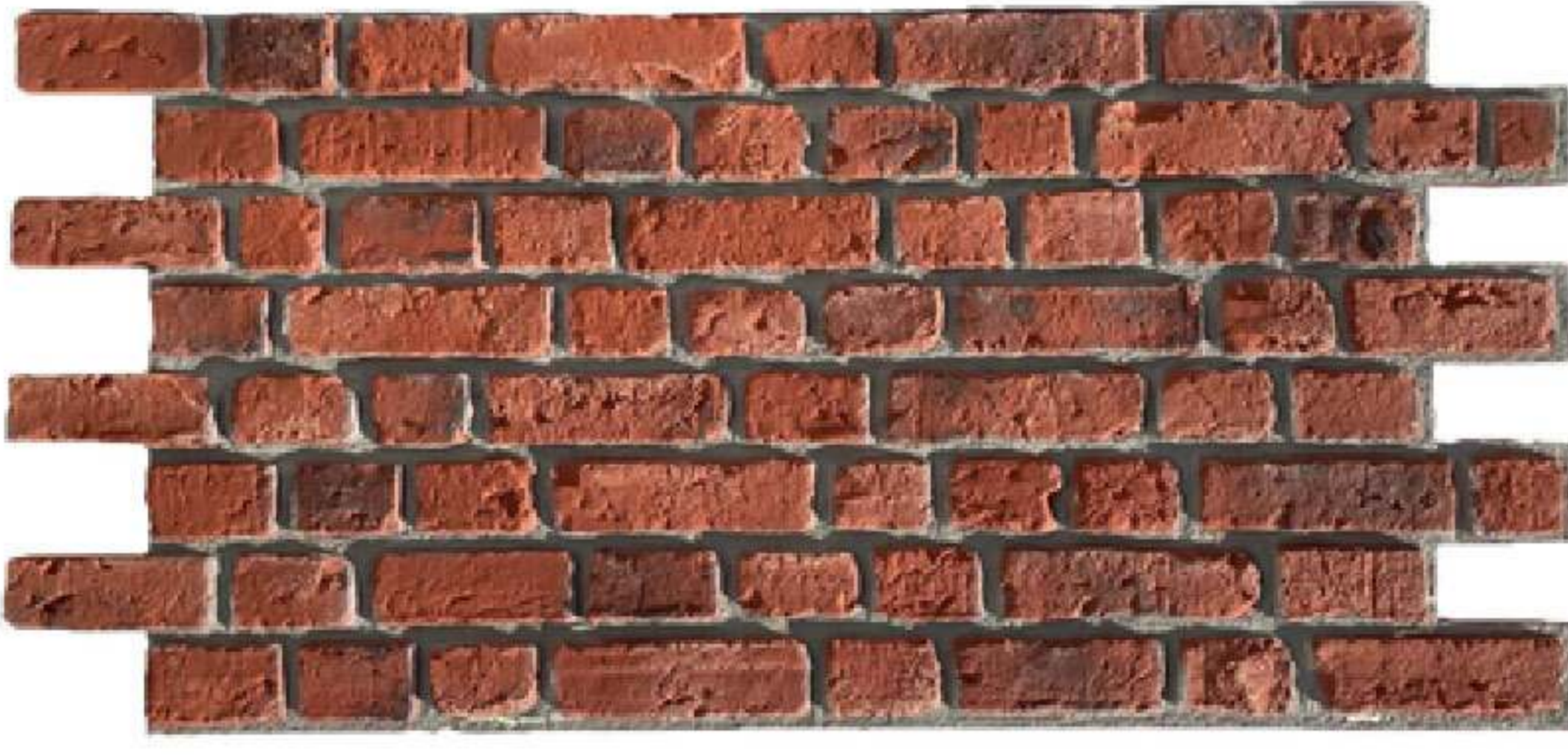

Suelo

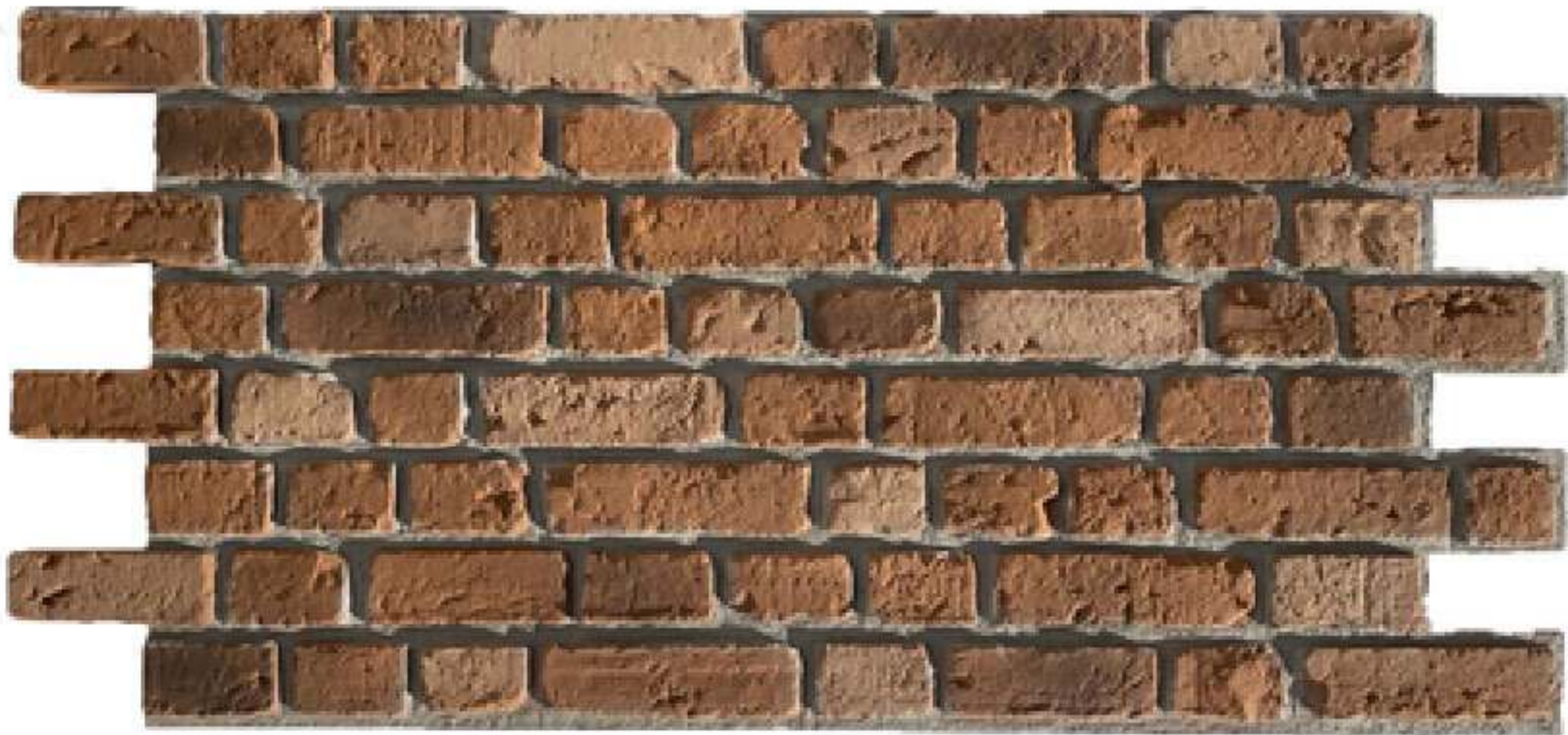

Dark Rustic

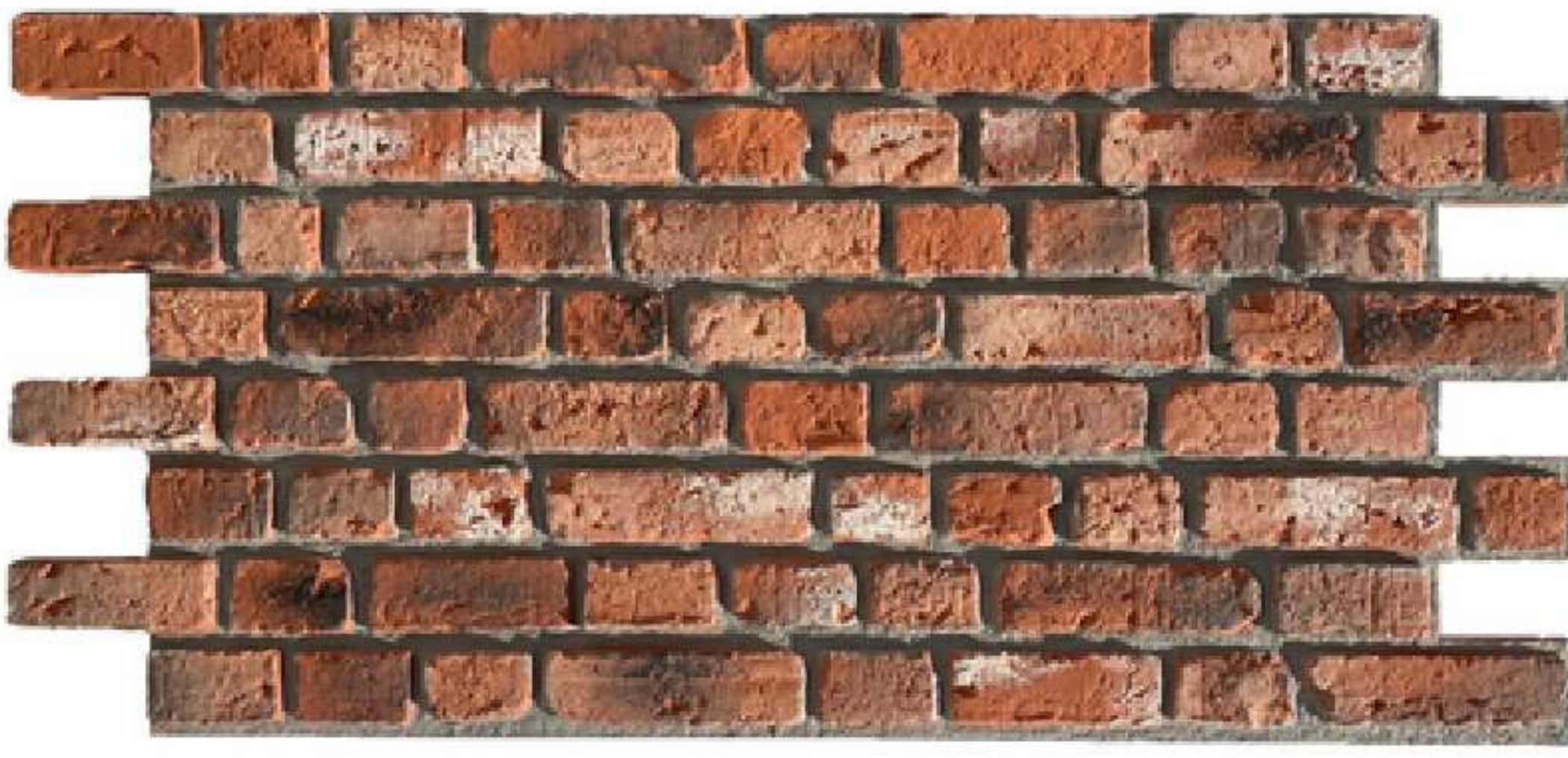

Vintage Retro

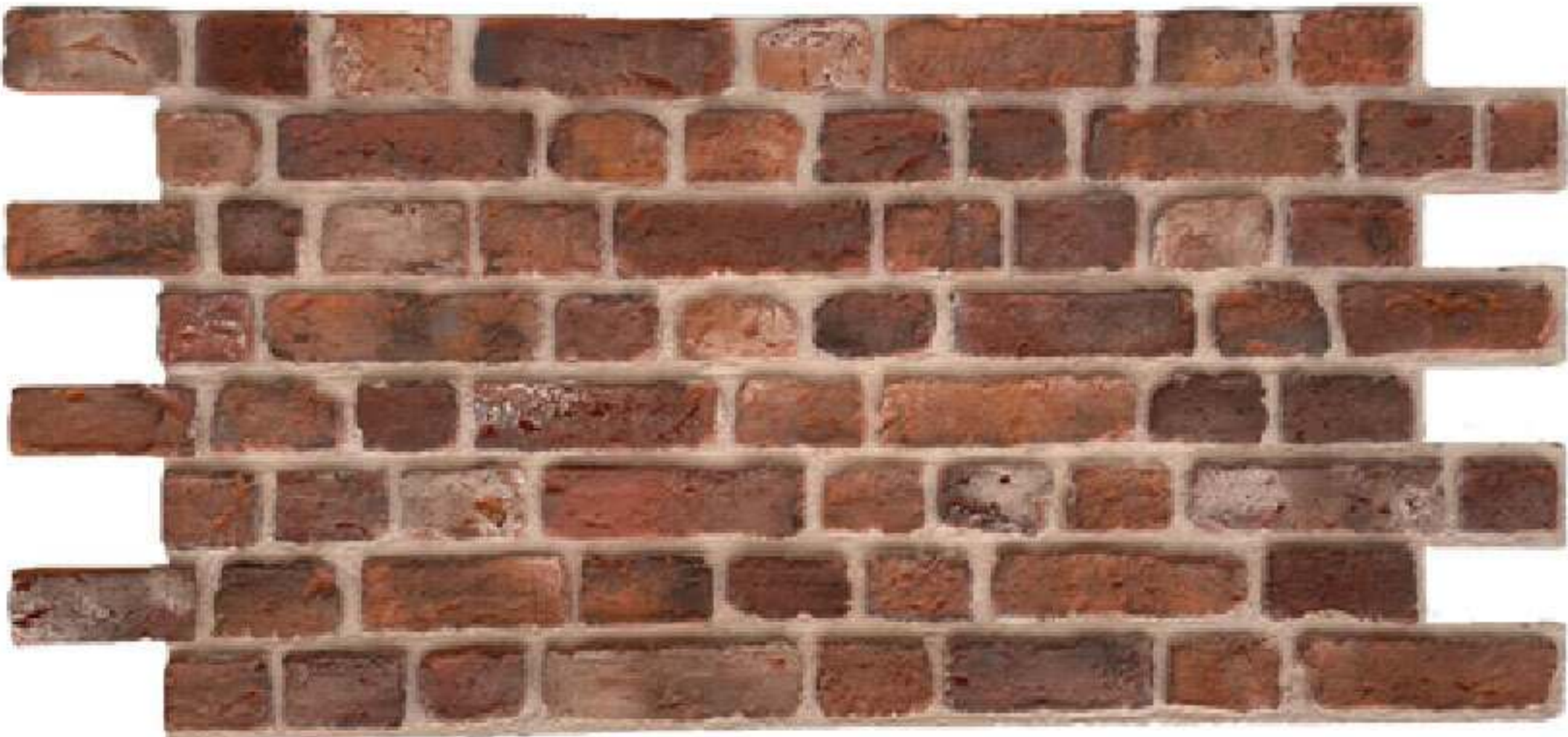



Ardesia



Dimensions : 0,6844 m²

Thickness : 4,4 cm

Rosso



Grey



Nero



Blancura



Ombra



Sandy





Piedra

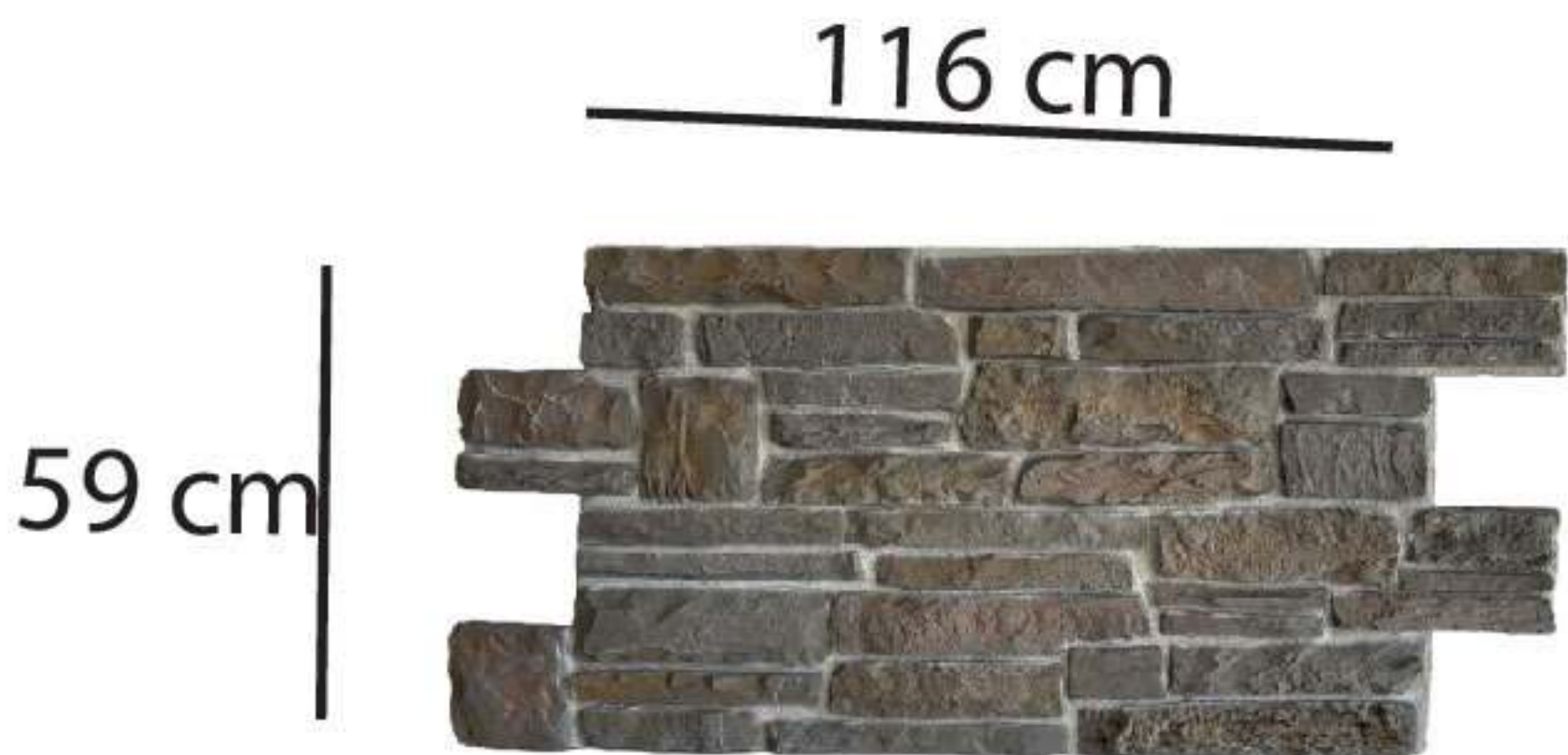

Dimensions : 0,6844 m²
Thickness : 4,4 cm

Marron



Amerillo



Blancura



Rosso



Blanca Noir





Pizarra

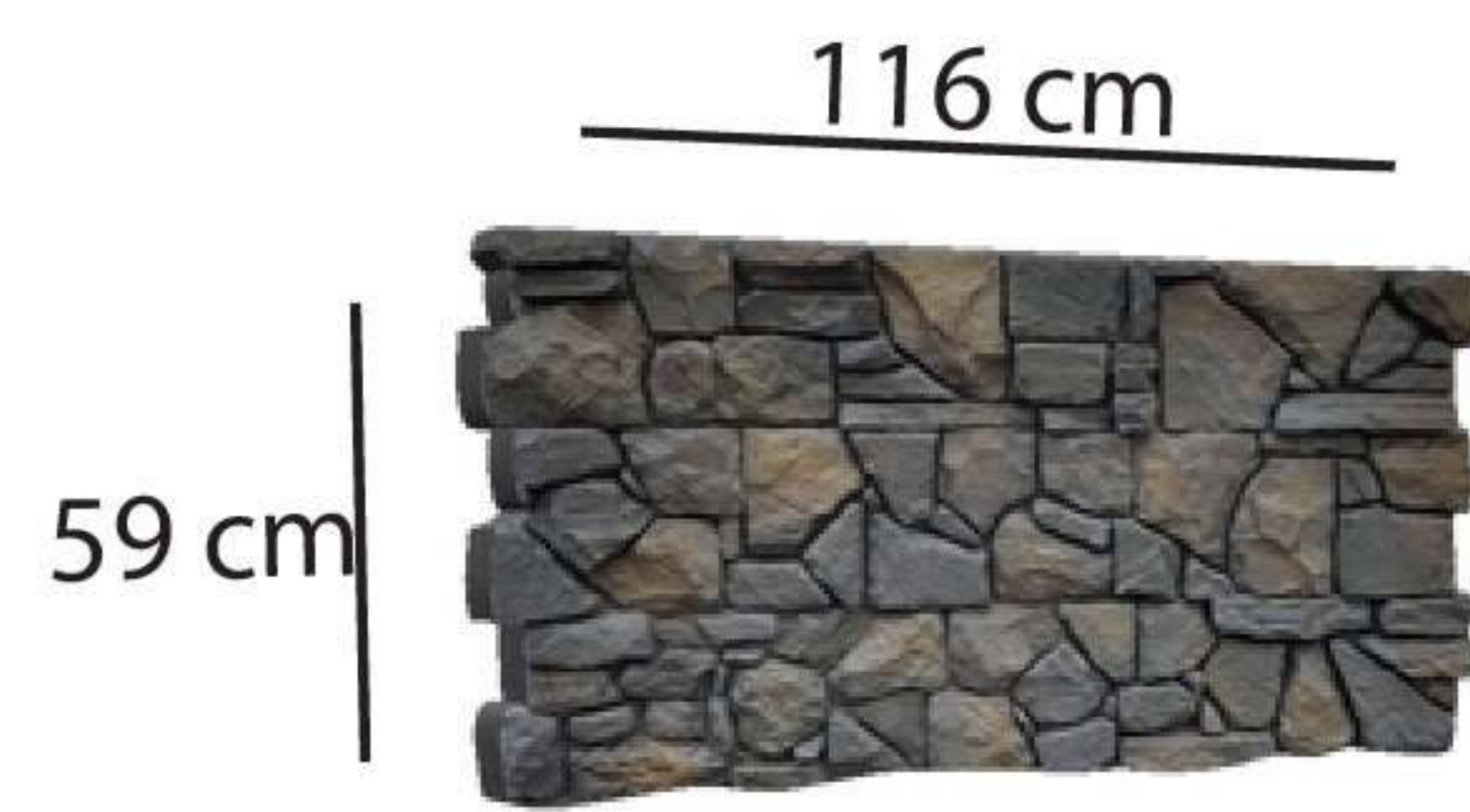

Dimensions : 0,6844 m²

Thickness : 4,4 cm

Giallo



Grey



Nero



Sandy





Hormigon

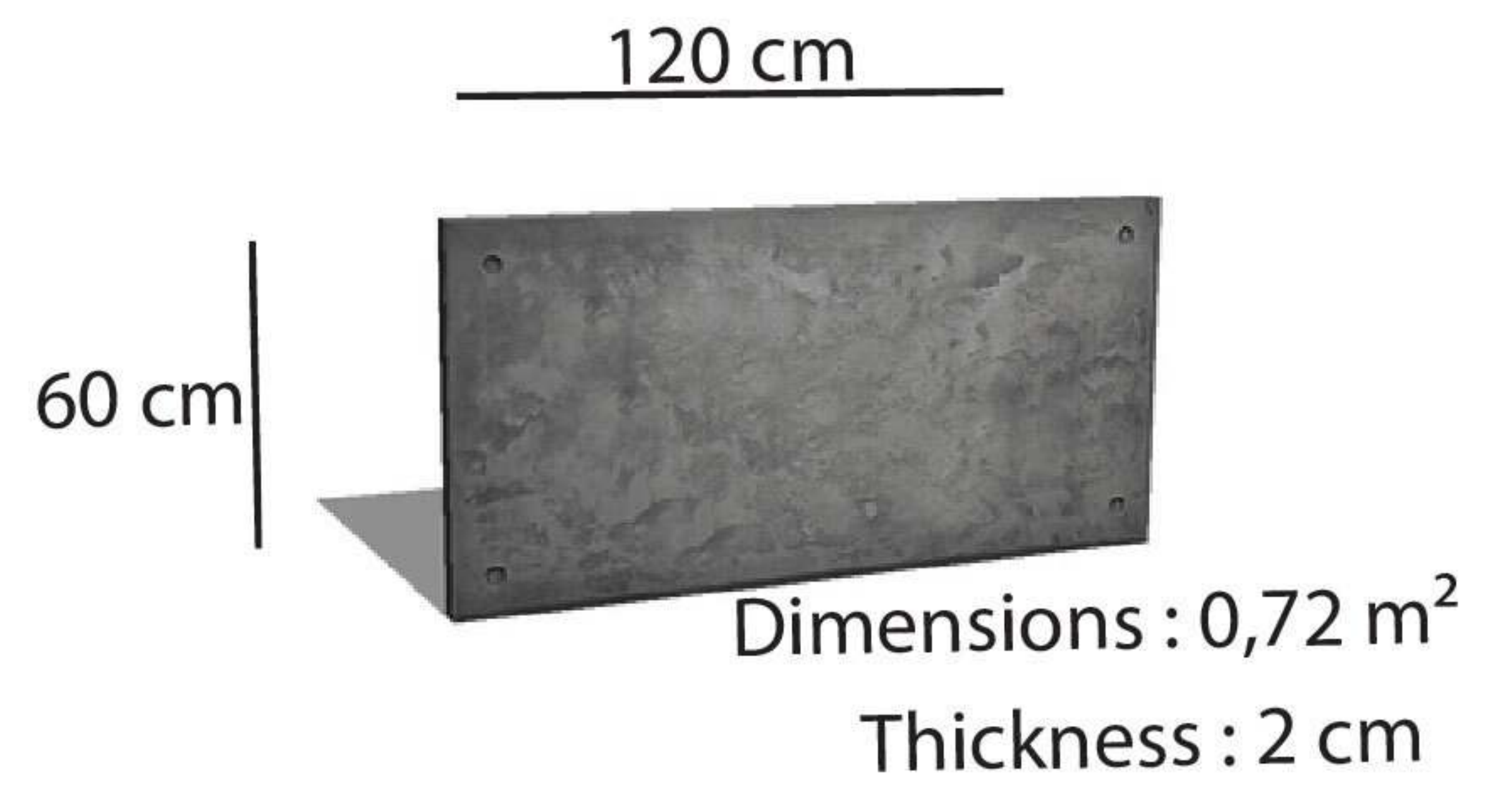

Abbronzza



Blancura

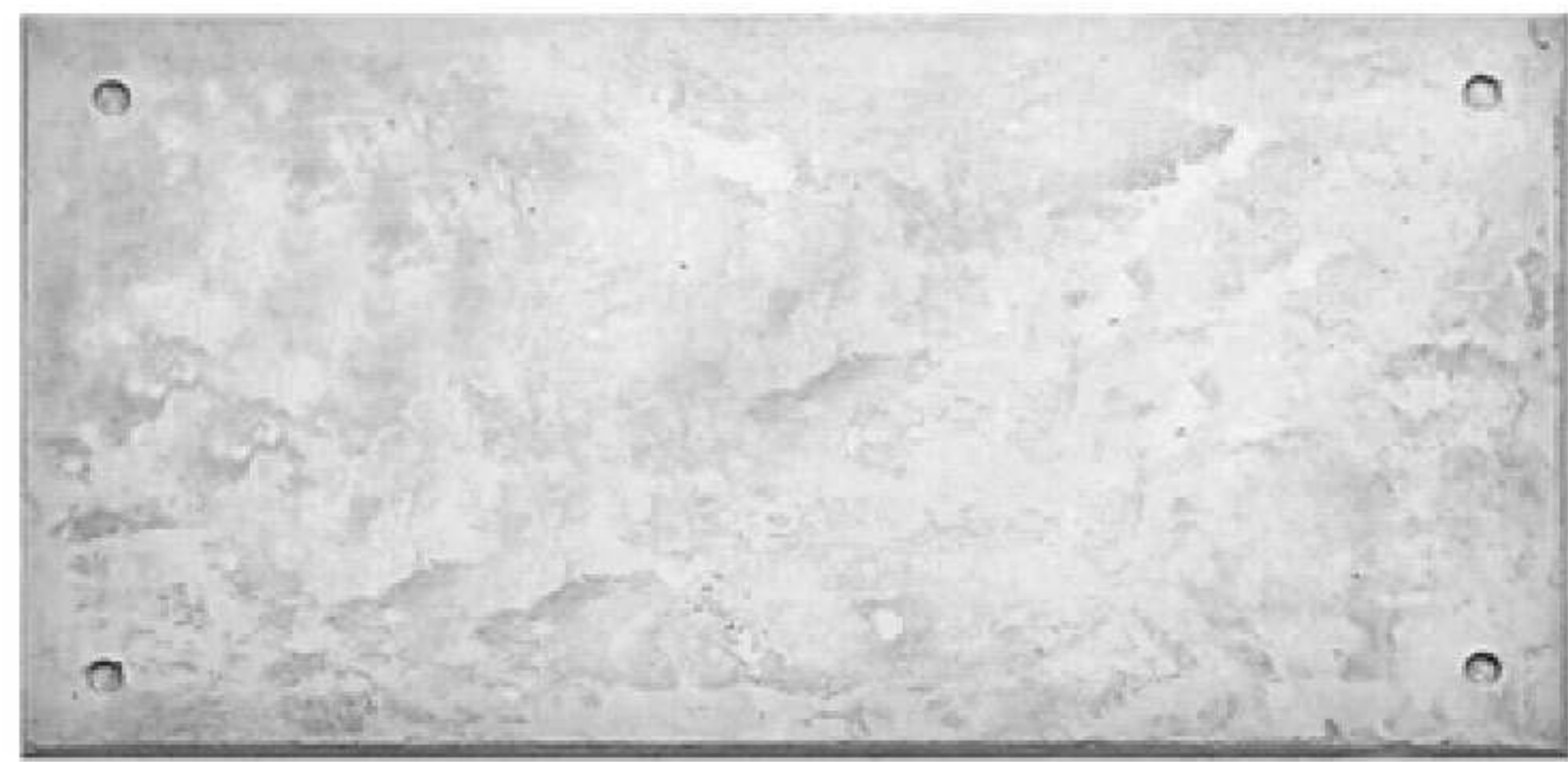

Dark Grey



Derecho



Grey



Oxid





Rocc

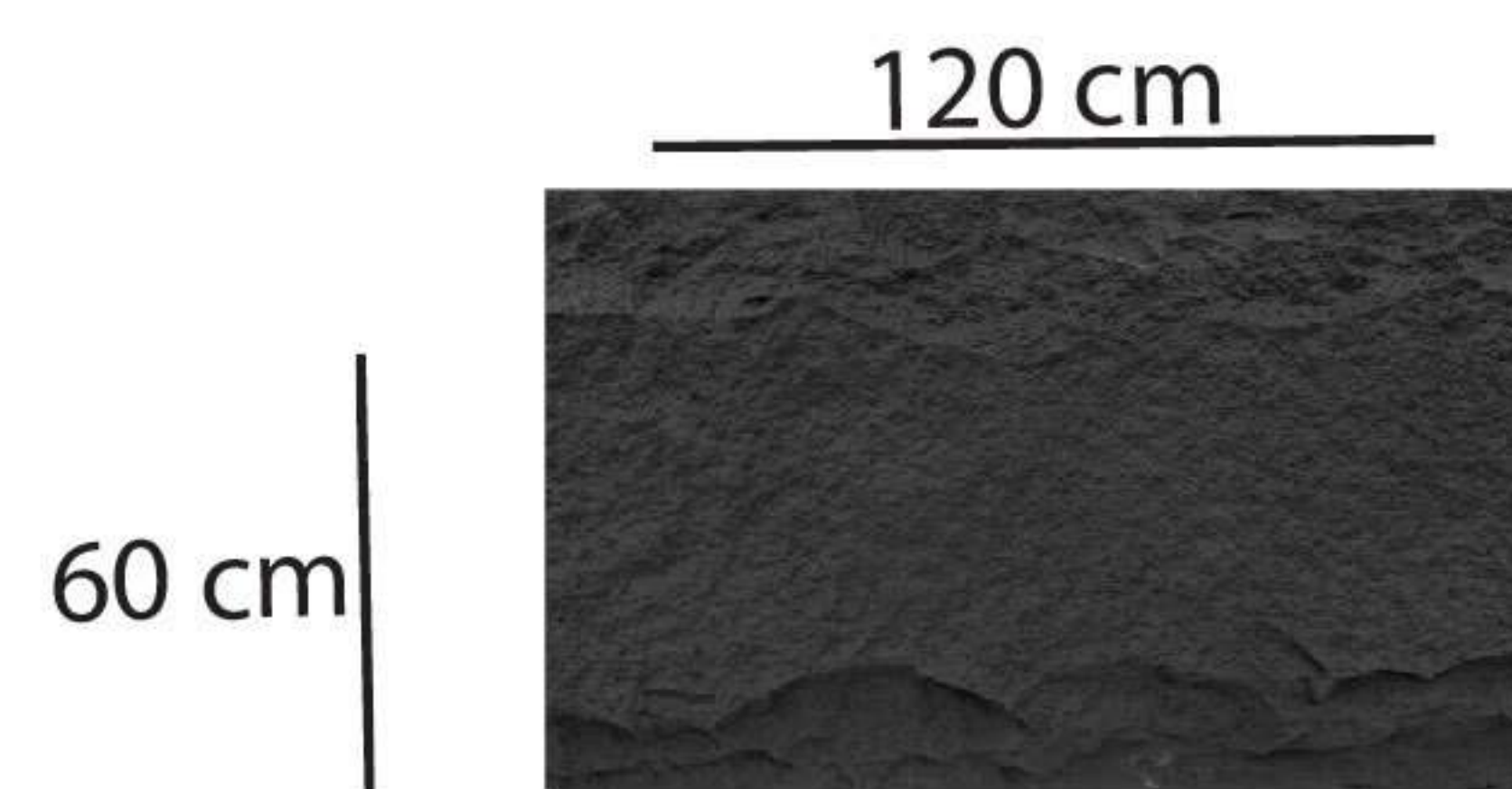

Dimensions : 0,72 m²
Thickness : 4-6 cm

Blancura



Nero



Dark Grey



Abbronzato



Sandstone



Antrasit

Dark grey

Sandstone

Blancura

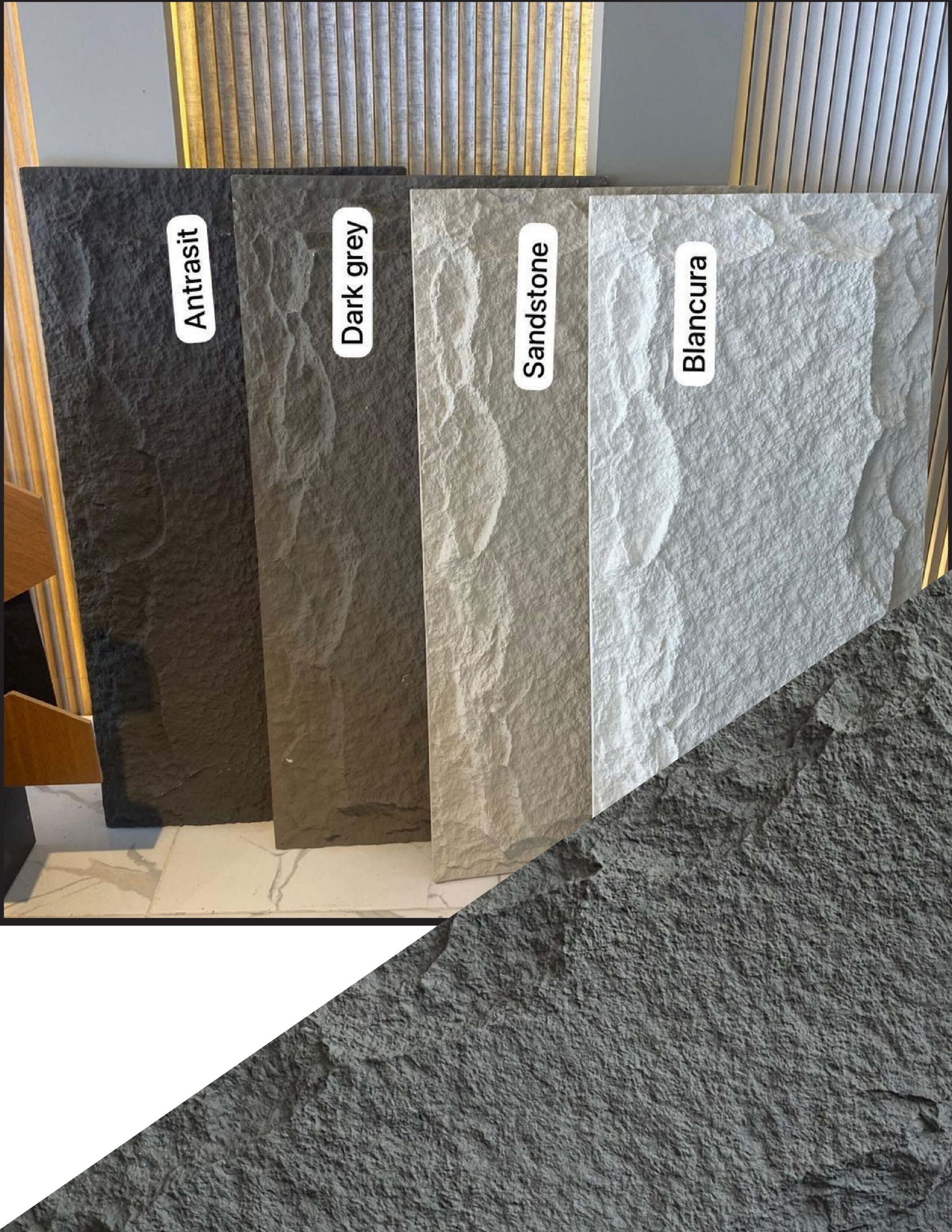



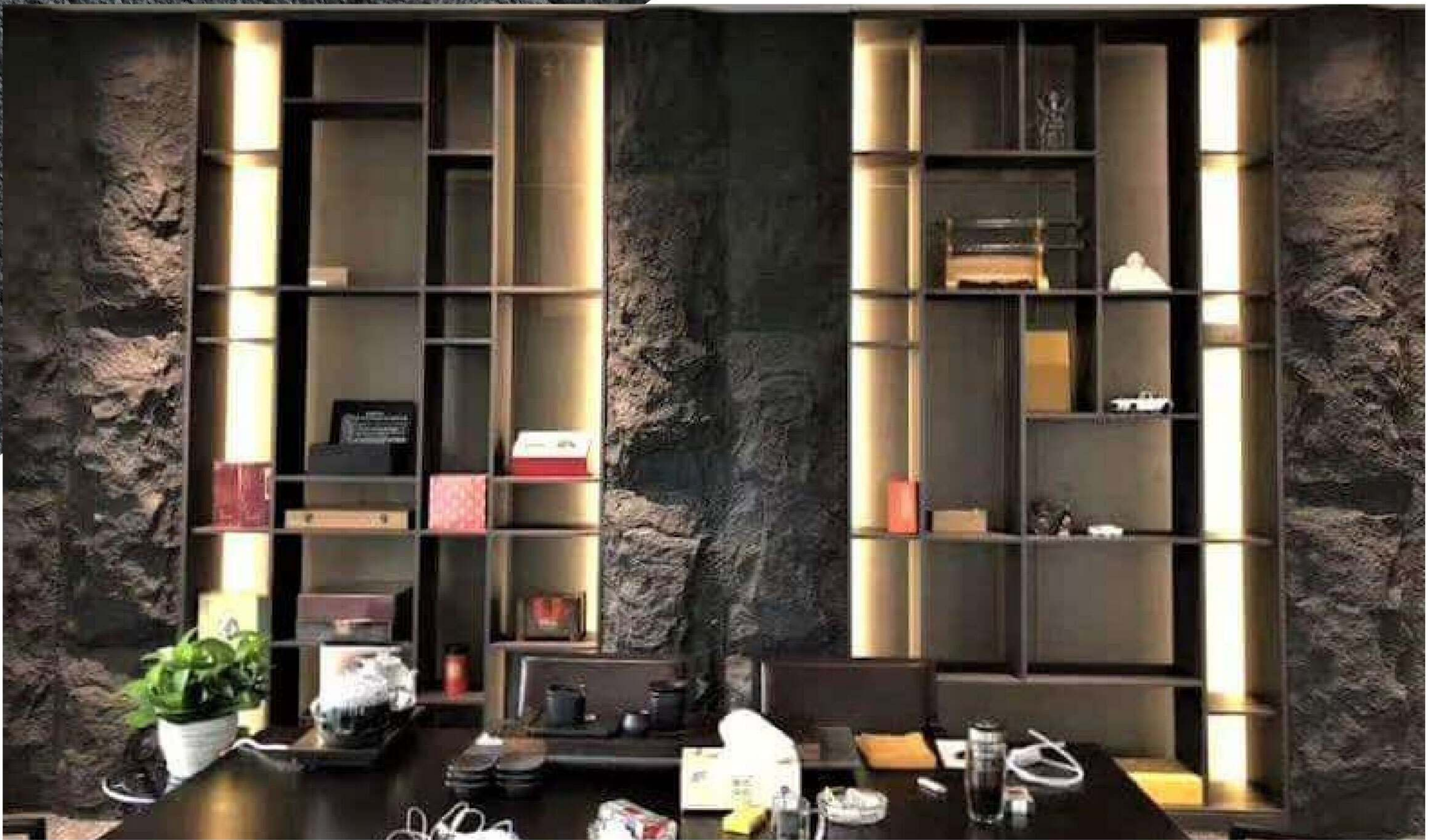

Kanyon

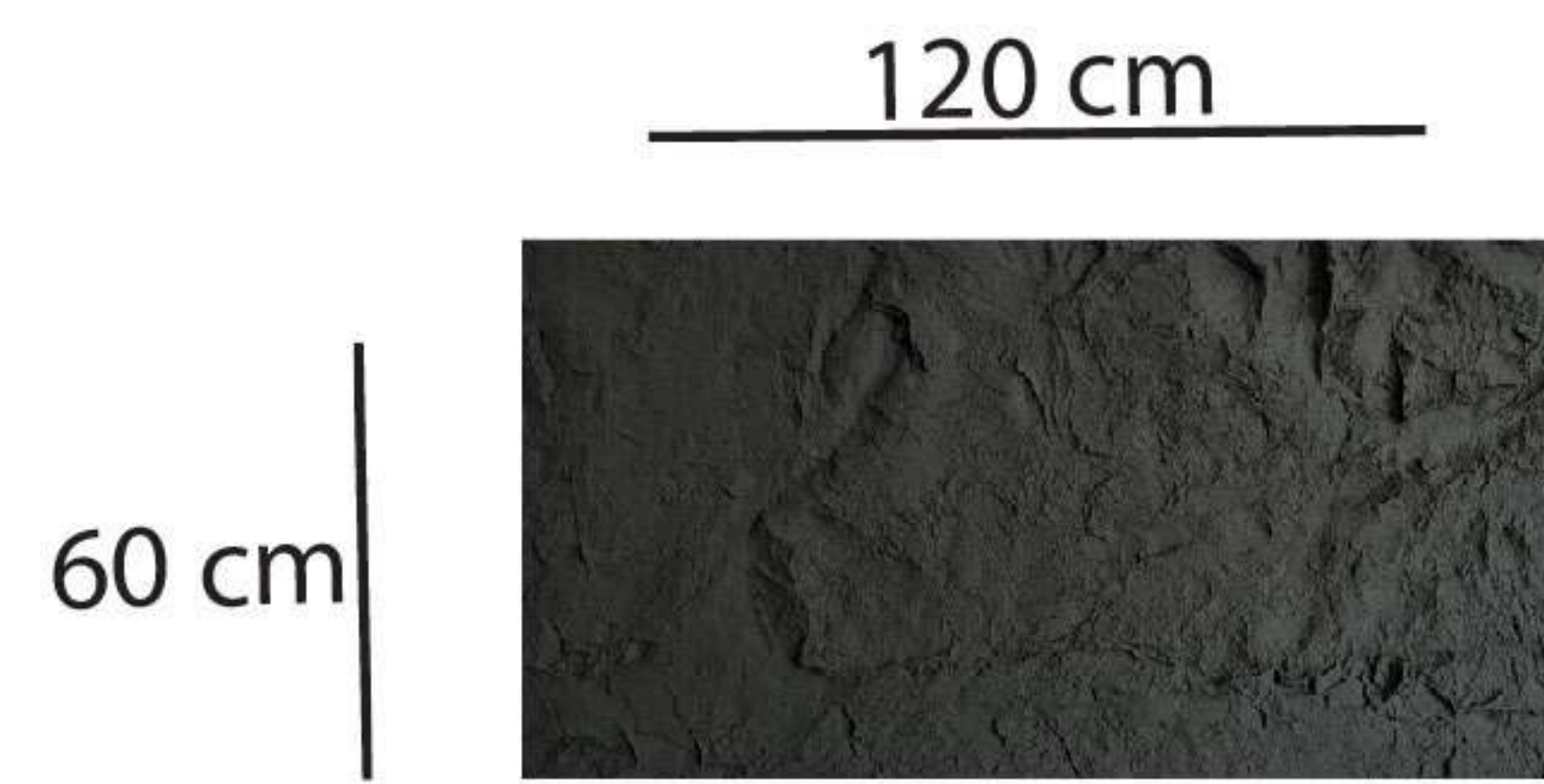

Dimensions : 0,72 m²
Thickness : 4-6 cm

Blancura



Negra



Sandstone



Beton

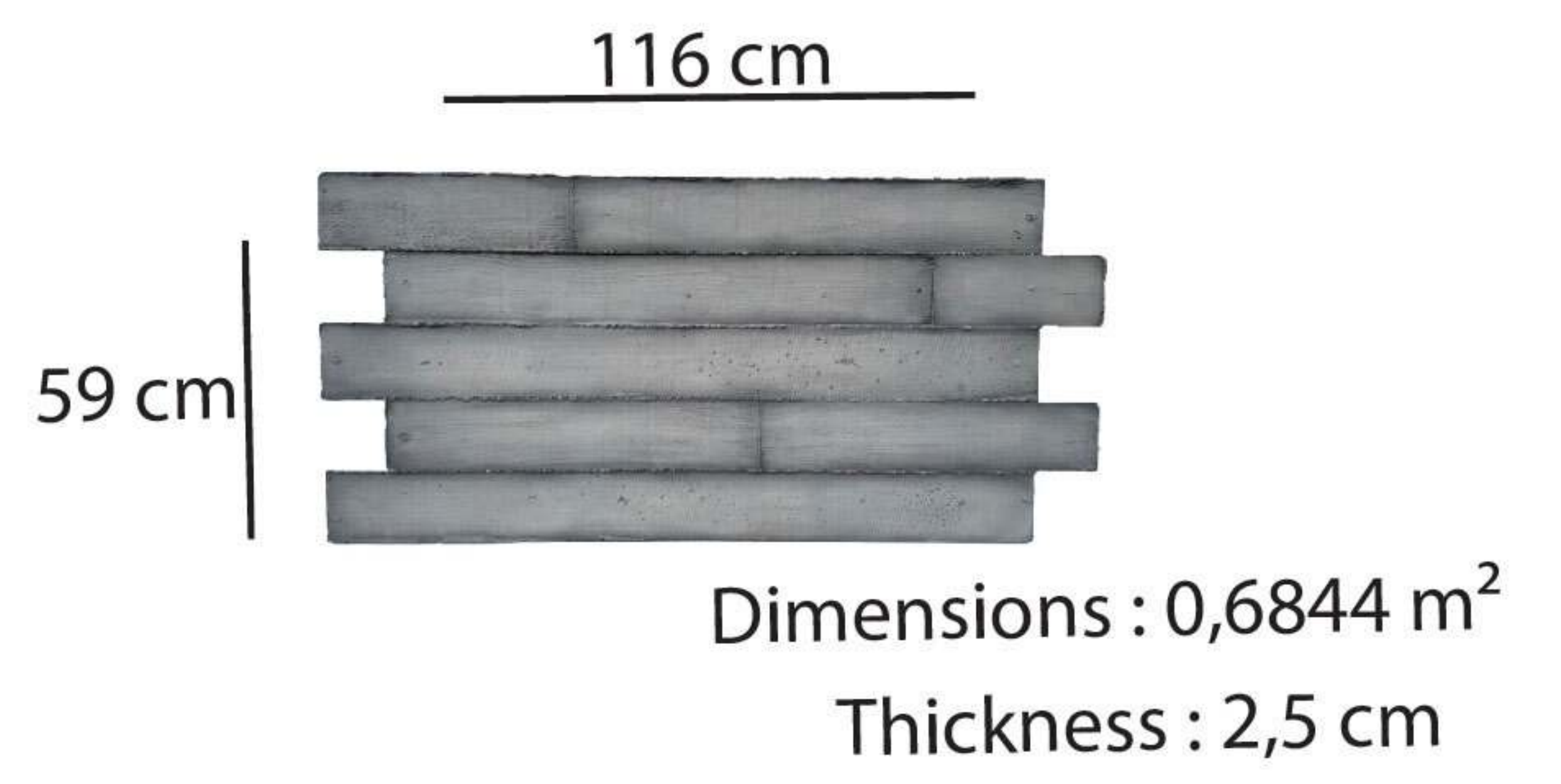

Grey

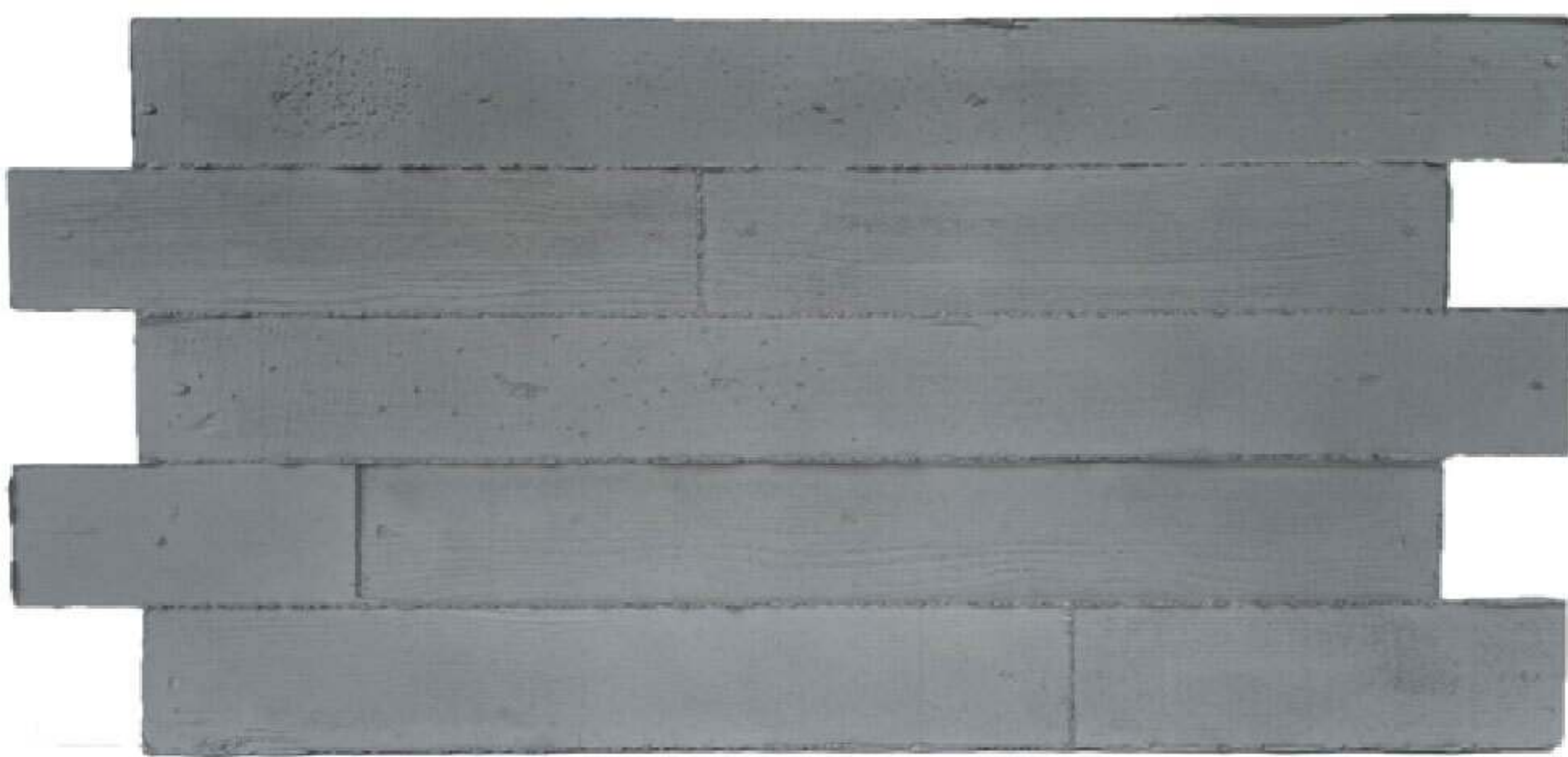

Grey Nero



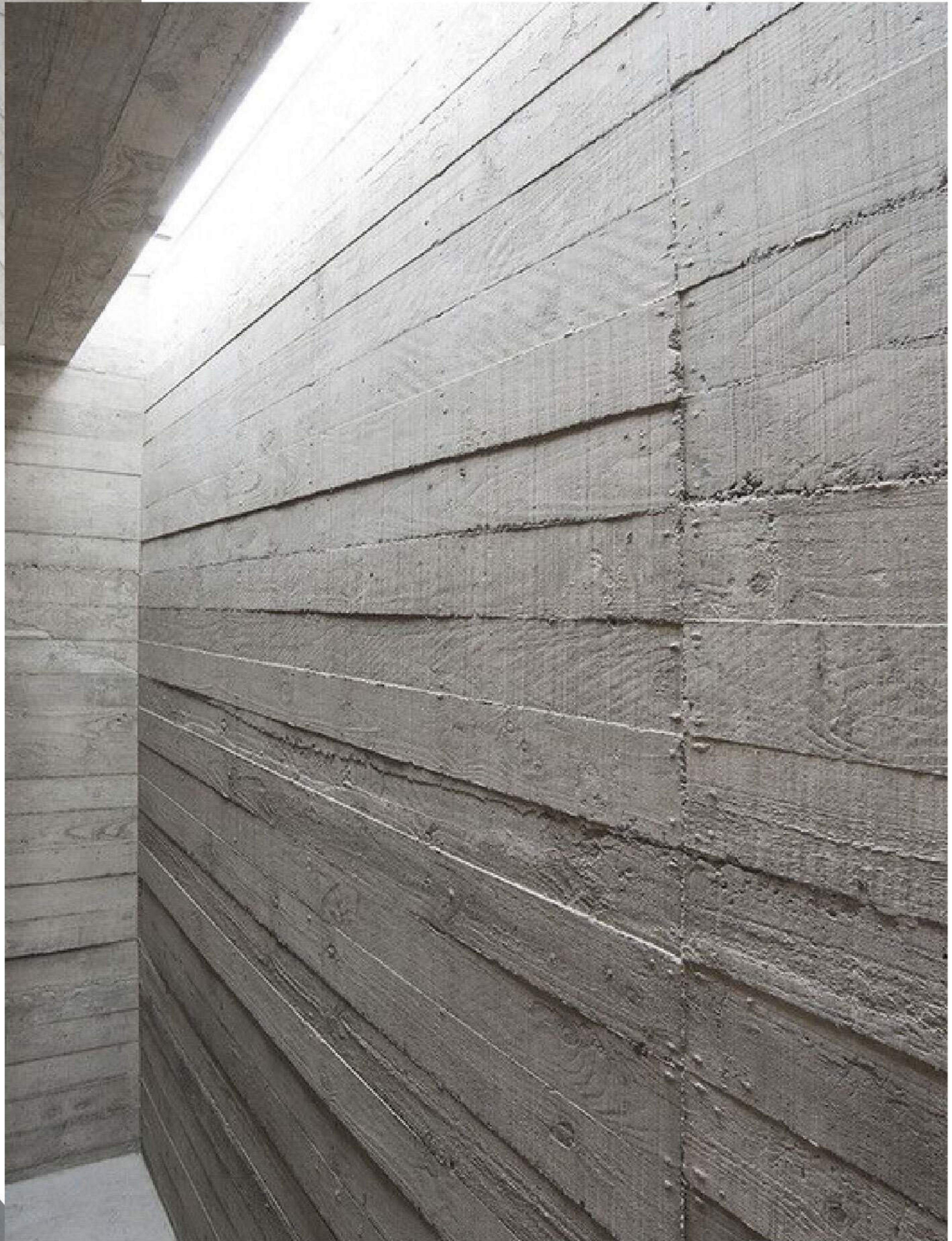

Assembly and application



Use a utility knife to cut the panel to fit the wall.



Apply the glue to the back of the panel



Stick the panel to the wall and press it for 2-3 seconds.



Apply sealant to the joints of the panels.



Using a brush, shape the paste according to the pattern.



Apply touch-up paint to the dried paste.







Easy Montage

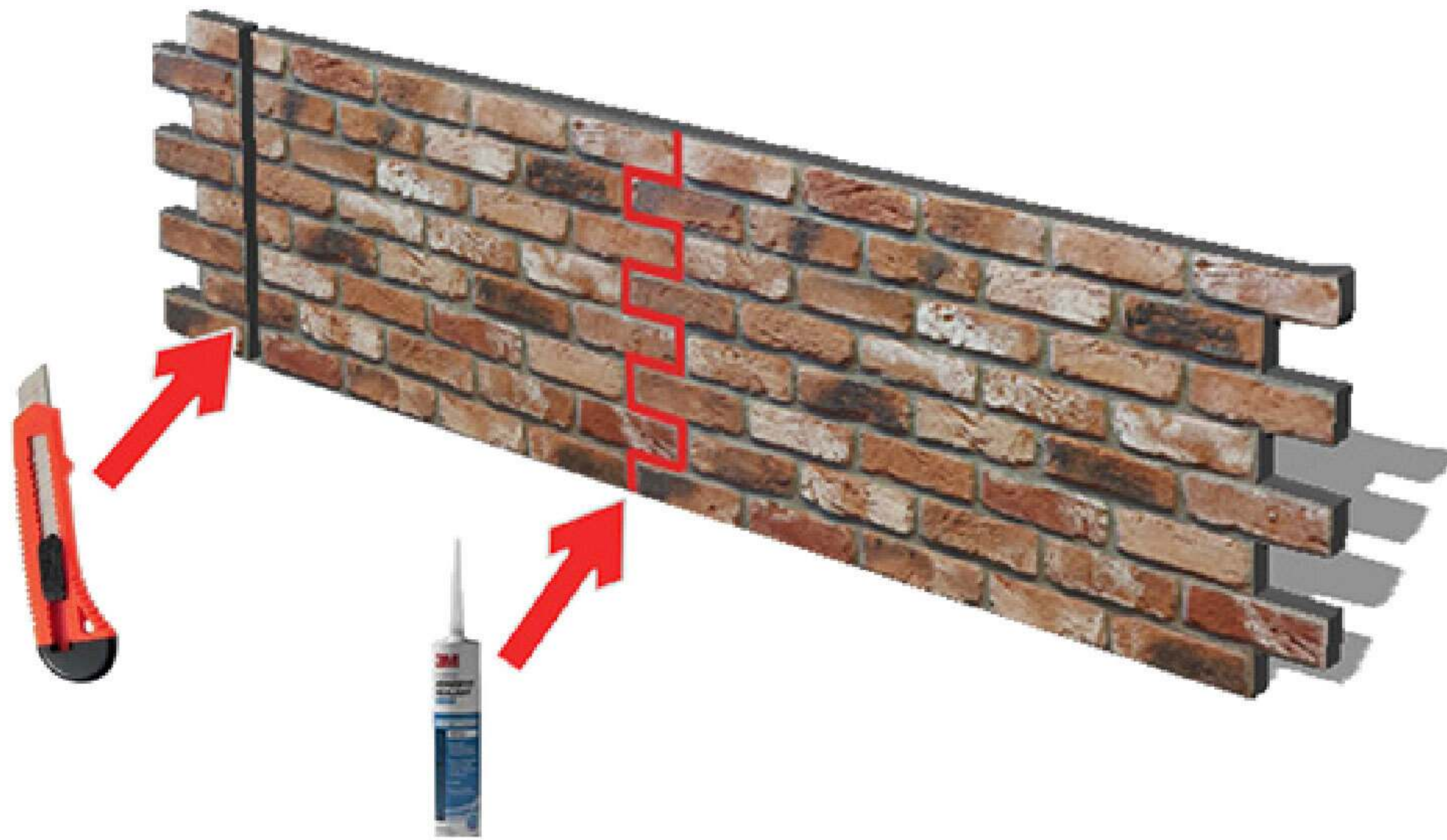

Heat Isolation

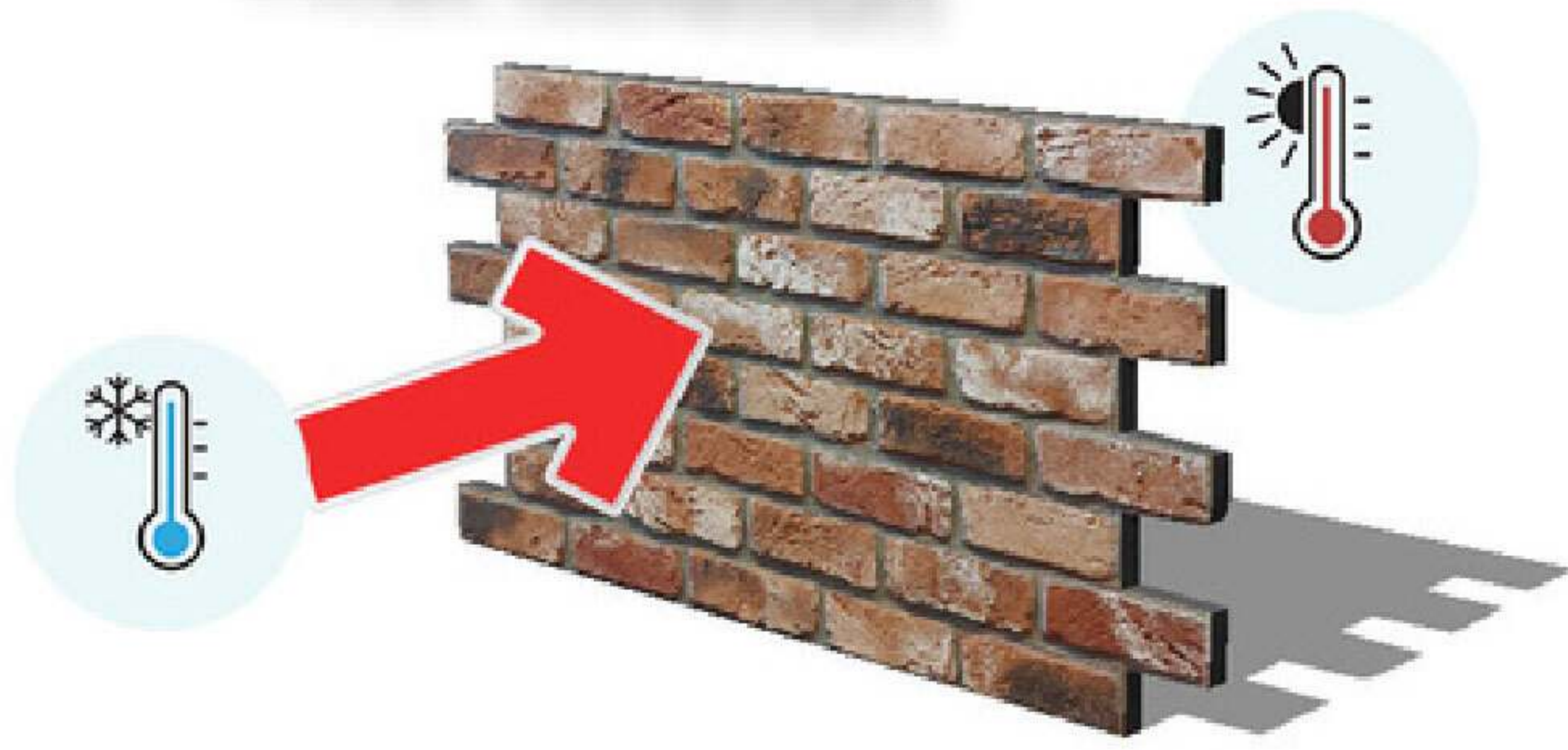

Sound Isolation

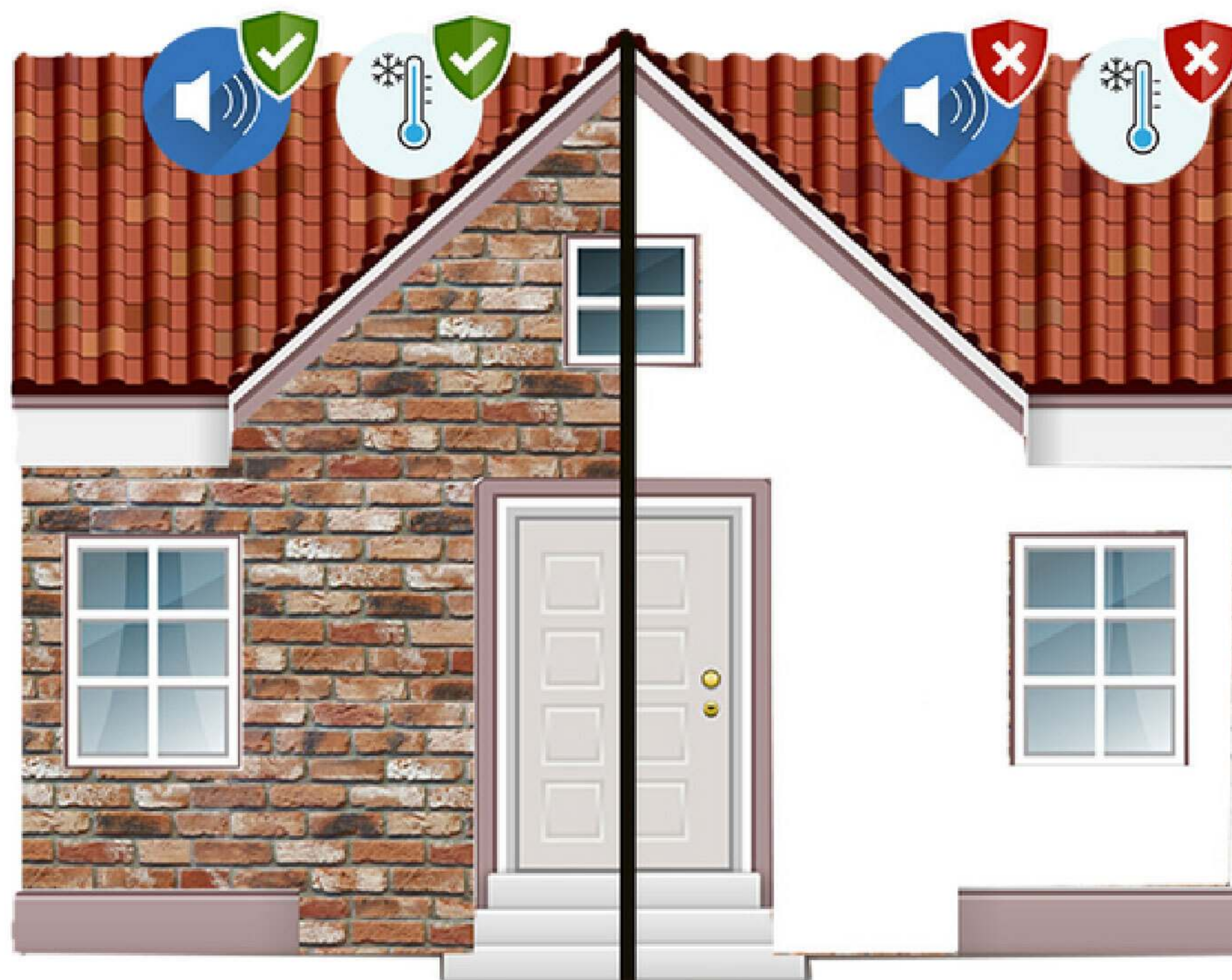
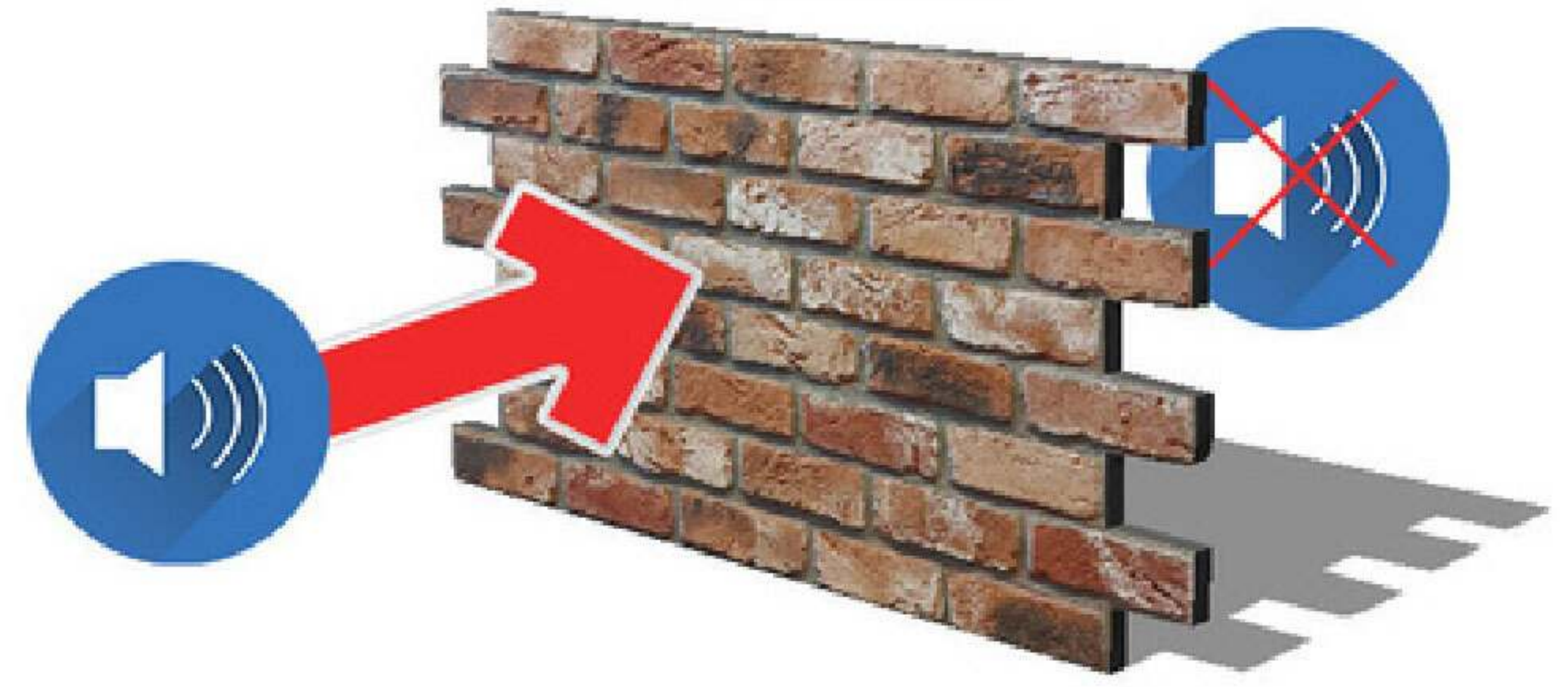

Technical characteristics

- Rigid is made from 100% pure dense polyurethane.
- Kanater polyurethane wall panel is the lightest yet strongest panel in the decoration sector.
- It has no dangerous ingredients. Fully cured product.
- Extremely hard and durable surfaces such as natural wood, concrete, brick and stone.
- High impact resistance.
- 100% odorless and not harmful to health.
- It has thermal insulation feature
- It has sound insulation feature
- The fire protection class is non-flammable class B2.
- The installation method is to layer foam onto any sustainable surface.
- Screw support can be provided in addition to adhesive if preferred.
- Easy to process and cut with normal carpentry tools.
- Products can be cleaned with water. It does not require additional cleaning, it can be easily wiped clean.

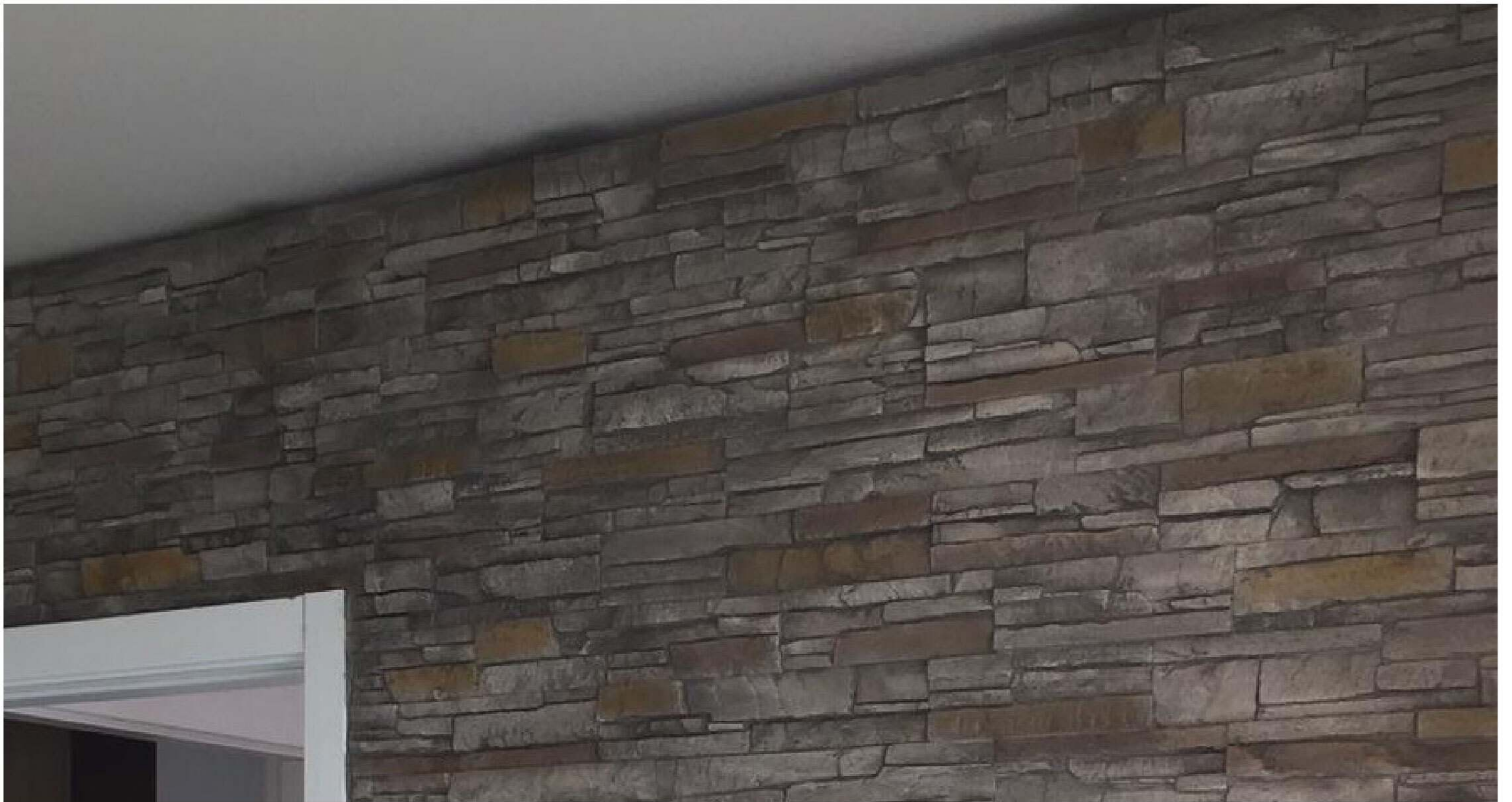

realistic
textures





 **KANATER**[®]
Decor & Construction

www.kanatergroup.com
Phone: +90 552 555 75 52
Export@kanatergroup.com

